

affinity[®]
living feature pools

half moon

mocha weave & black aluminium
instructions



Enjoy the sight
and sound of
moving water
and aquatic life,
day and night
all year round



Half Moon Assembly Instructions

Getting to know your Affinity living feature pool

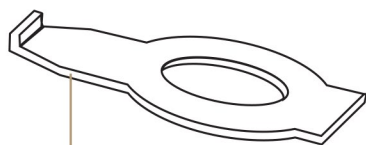
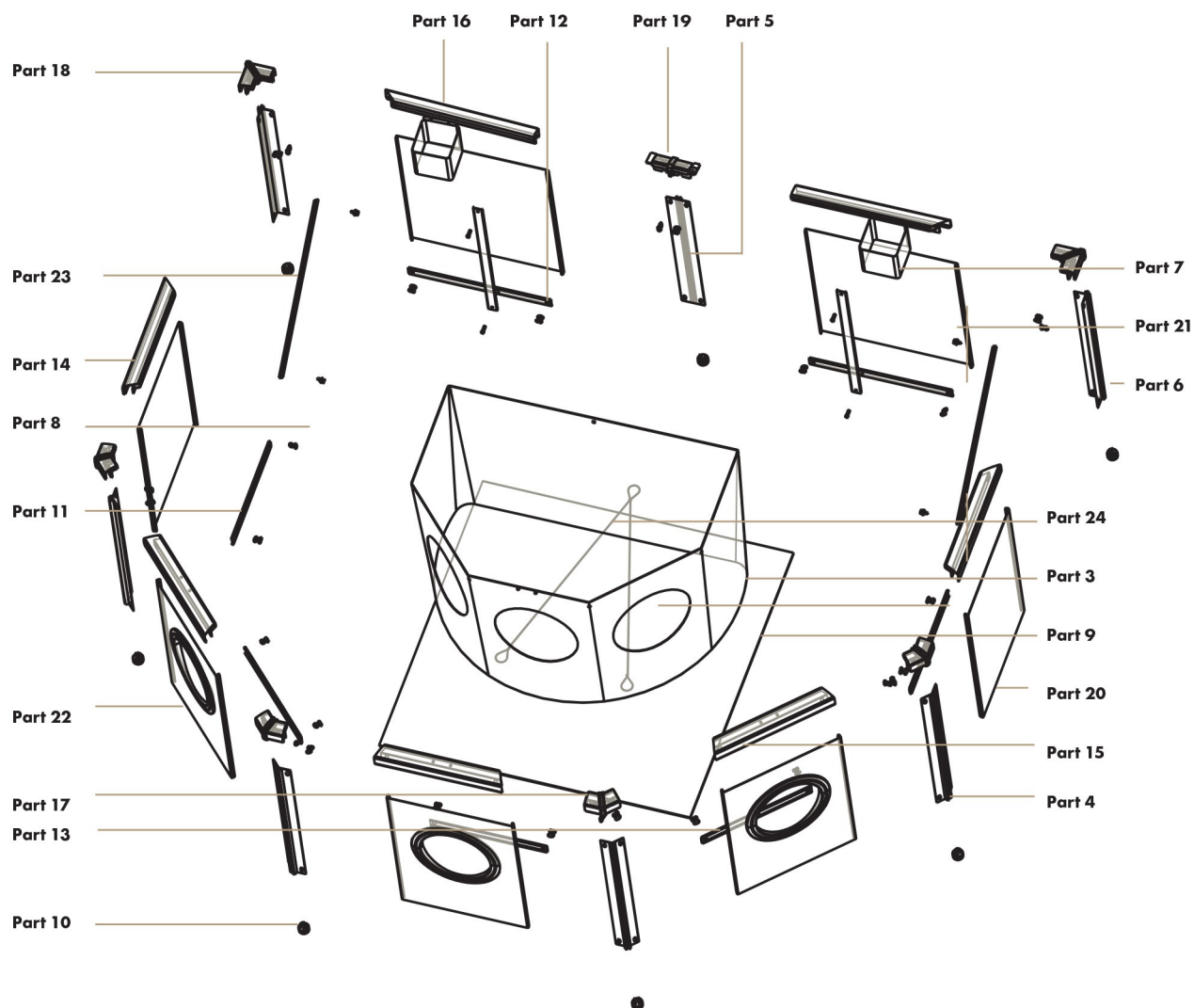

Part 1

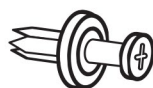

Part 8



Part 10

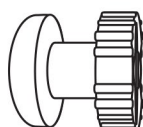

Part 2

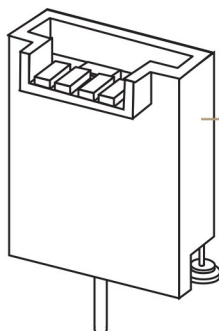

Part 25

Part List

Part Description	Quantity	Part No.
Tool	1	1
Plastic keys	28	2
Halfmoon liner	1	3
135 Degree Legs	4	4
180 Degree Leg	1	5
90 Degree Legs	2	6
Planting Basket	2	7
Fixing Pins	12	8
Underlay	1	9
Leg Feet	7	10
Leg Cross Braces Small	2	11
Leg Cross Braces Large	2	12
Leg Cross Braces Front	3	13
Top Rails Small	2	14
Top Rails Front	2	15
Top Rails Large	3	16
135 Degree Trident Connectors	4	17
90 Degree Trident Connectors	2	18
180 Degree Trident Connectors	1	19
Mocha Weave Panels	2	20
Mocha Weave Panels Back Large	2	21
Mocha Weave Window Panels	3	22
Support Bars	4	23
Strengthening Wire	1	24
Waterfall	1	25

Step by Step Guide

Step 1

Please remove all of the relevant parts from the packaging and double check that all of the items are enclosed, use the complete parts list and the exploded diagram to check this.

Step 2

Identify a suitable area where your Affinity Pool can be placed, ensure that the area is level with a firm base and is free from stones or any other debris that could damage your liner bag.

Step 3

Using your supplied underlay (part 9) lay it flat over the cleaned area ensuring it covers the entire area where the liner will sit. Underlay is very important as it protects your liner bag from puncture or damage and prevents any possible unwanted leaks.

Step 4

Now using all of the top rails (parts 14, 15 & 16) and all the trident connectors (parts 17, 18 & 19) connect them together into a halfmoon shape, each top rail is labelled to help aid you in correct construction. The trident connectors in image 1 allow the top rails to slot into each other, ensure the bottom oval hole is completely free. Image 2 shows the top rail incorrectly inserted and image 3 shows the top rail correctly inserted.

The top rails are labelled A, B & C as per image 5 and should fit together as per image 5 at the end of this step.

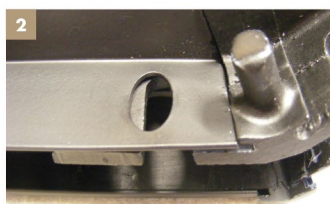

INCORRECT INSTALLATION

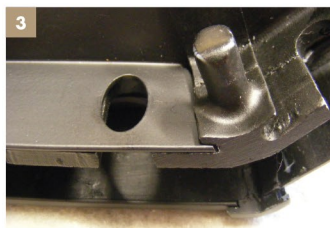

CORRECT INSTALLATION



CORRECT INSTALLATION

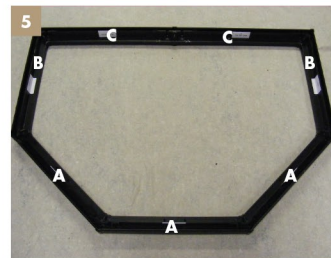

Step 5

Using the legs, insert them into each of the trident connectors as per images 1 & 2. Ensure the cut in sections (as per image 1) are not inserted first but are located at the top of the leg once inserted and line up with the oval holes. The 180 degree leg (part 5) fits the flat trident connector (part 19). The two 90 degree legs fit the 90 degree trident connectors (part 18). See the exploded diagram and step 7 for reference.



INSERT INCORRECT WAY



INSERT CORRECT WAY



Step 6

Your Affinity Pool should now have all 7 of the legs inserted the right way up and be ready to have the plastic keys (part 2) inserted at the bottom of the top rails. It should look like the image below with all 7 legs inserted.



Important: Ensure the angled cut section is at the top of each leg to help aid panel insertion.

Step 7

This step requires you to use 14 of the plastic keys (part 2), insert them into each of the oval holes at the base of all the tridents on both sides, 2 per trident. Image 1 & 2 shows the first keys being inserted into the oval holes. The oval holes must not be covered but be completely free and open to ensure the keys can fit in easily. Continue to insert all 14 keys as per image 2.

Now using the supplied tool (part 1) turn the keys a quarter turn so they lay flat and lock into position as per image 4. Continue to do this to all 14 keys around the base of the pond until all 7 legs are firmly connected to all 7 of the trident connectors.

Note: Reverse tool to lock corner keys, see image 5.



Insert keys



Unlocked keys



Turning key



Locked keys

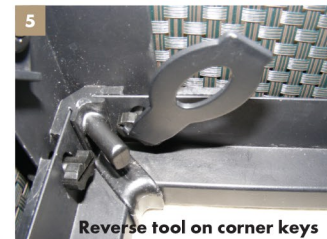

Reverse tool on corner keys

Step 8

Now would be a good time to look at the exploded diagram and take note of the position of each of the windows on the liner bag (part 3). As all 3 windows are positioned at the front of the halfmoon, you must make sure all 3 window panels (part 22) are positioned at the front as per the exploded diagram.

The panels are divided between A, B & C which help guide you on which panel needs to go where.

Identify the window panels first, labelled A (part 22) and slot them into the correct legs, see exploded diagram. You will have to use two hands and slot both sides of the panel at the same time to ensure it fits easily and correctly between the legs to the bottom rail, see image 5 for reference. Ensure the window frames are facing outwards and are slotted into the legs the right way by looking at images 1 & 2.

Labels on the panels which have "to the inside" on them means that the side of the panel needs to face towards the inside of the pond.

Tip: When sliding the panels into the curved slot sections on the legs ensure the panels are wet with water. This will aid the slotting process of all the panels into the legs.

Image 2 and 4 show how the panel should be installed correctly with both labels on the inside, when the panel is correctly slotted into the bottom of the leg it should slot behind the top rail nicely as in image 4. Image 6 shows how the panel should look when fully inserted, ensure all the panels are flush to the top leg when inserting as the feet will need to sit on top.

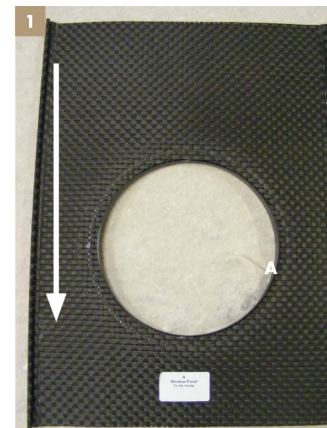

1

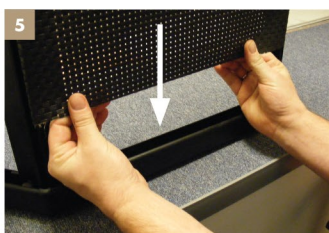
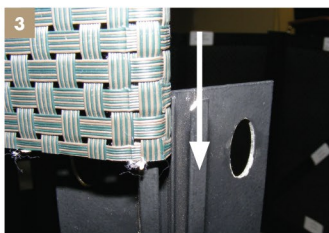
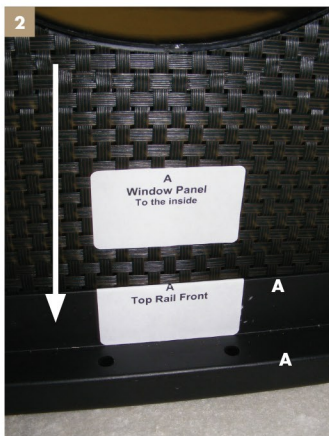

Step 9

Once all the A window panels have been inserted it will look like image 1. The sections without panels are where the non window panels labelled B & C will be positioned.

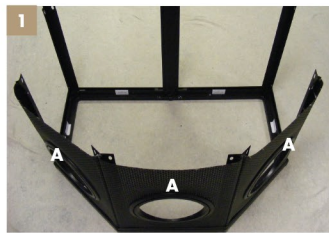

Step 10

Now the non window panels B & C (parts 20 & 21) can be inserted into the remaining empty sections on the Affinity Pool frame.

Firstly insert the B panels to the sides of the frame which have the top rails also labelled B. Then insert the large panels C to the large top rails at the back of the frame which are also labelled C.

Use Image 1 & 2 as a reference.

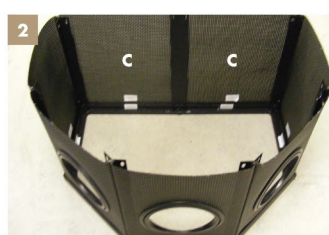

Step 11

Now using the leg cross braces (parts 11, 12 & 13) which are also labelled A, B & C match them up with the corresponding panels. Next using the remaining 14 plastic keys insert 2 of them to each of the 7 legs, ensuring the braces are the right way round (see images 1 & 2). The leg cross braces are A, B & C to match the top rails & panels.

Important: Do not lock any of the keys until all the cross braces have been loosely inserted with the keys into the 7 legs. Locking them one at a time will prevent you from assembling the final leg cross brace easily.

Once all the keys have been inserted using the provided tool (part 1) turn all 14 keys a quarter turn so they lock into position as per image 2 below.

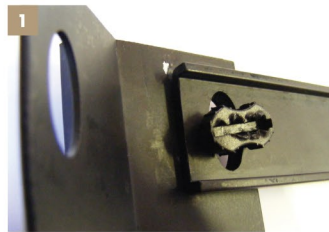

INCORRECT INSTALLATION TO THE OUTSIDE



CORRECT INSTALLATION TO THE INSIDE



Step 12

Now the 4 support bars (part 23) will need to be added to the pond frame, as per the exploded diagram and images 2 & 3 push fit them into place using the fixing pins (part 8). Ensure these bars are installed the right way round by taking note of the sticker on the bars and images 1 and 2.

1 Fixing pin incorrect



INCORRECT INSTALLATION TO THE OUTSIDE

2 Fixing pin correct

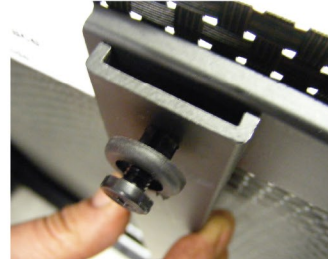

CORRECT INSTALLATION TO THE INSIDE



5

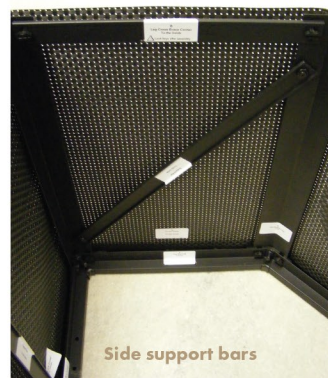

Step 13

Check all parts are secure and correct and then attach the supplied feet (part 10) to the end of the 7 legs. These clip into place easily and ensure the pond is level and secure. Feet can fit all the 90, 135 & 180 degree legs. See image 1 & 2.

Then using the supplied strengthening wire (part 24); attach each hoop end by sliding it onto the body of the 3 feet highlighted as per image 3 and 4.

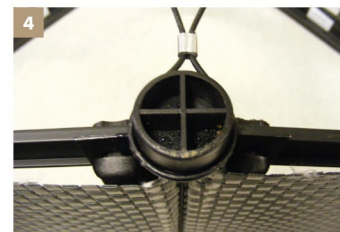
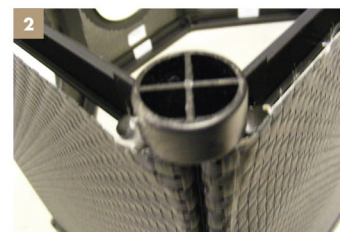

Important: Before moving on to step 14, ensure all the labels are removed from the panels, as you will be unable to remove them once the liner bag has been inserted.

Step 14

Now it is time to turn over the Affinity Pool so it's standing on its feet and insert the Liner bag (part 3). Carefully unpack the liner bag so it fits inside like in image 4 below. The liner bag can now be attached.

You will see on image 1 that a hook is present on the trident section, this enables you too hook each eyelet on the liner to the hook on the trident connector. Ensure the liner is positioned with the windows correctly lined up with the windows on the A window panels, see exploded diagram and image 4 for reference.

To be able to hook the liner easily the eyelet must be raised 90 degrees and pushed to the back of the hook before allowing the eyelet to drop down behind and become secure as shown in images 2 & 3 below. Continue to do this to 6 of the eyelets around the pond but keep the centre hook on the back of the pond free as shown in image 5 for step 15.



Step 15

Now place the Inpond All-In-One inside the pond and thread the low voltage pump cable and the UVC cable between the liner bag (part 3) and the back large panels which are labelled C. See Inpond instructions on how to set up the pump and filter correctly. Do not turn on the Inpond at this time.

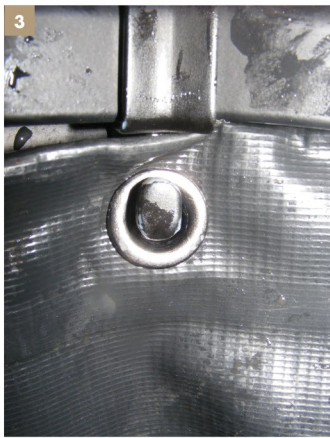

Step 16

Now add the supplied waterfall (part 25) to the Affinity Pool, underneath the waterfall are two screw feet as seen in image 1. Gently screw the waterfall clockwise to the centre line between the two back top rails until its hand tight as in image 1 & 2. Once the waterfall has been successfully attached the Inpond pump and filter can be connected as seen in image 3. See the Inpond instructions for successfully installing to waterfalls page 17 of the Inpond all in one instruction leaflet.

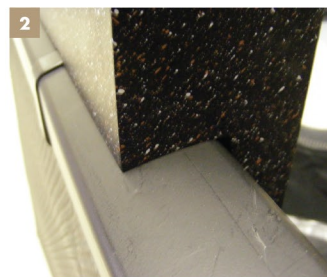
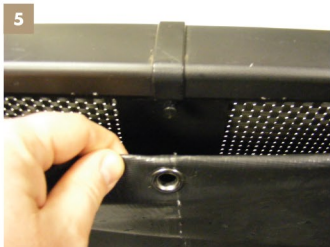

Step 17

Now the Affinity Pool is in place, the underlay can be neatly folded and tucked under the liner bag. Ensure that it's fitted correctly by slightly lifting up the pond to allow you to fold and push the underlay under the panels and the liner bag.



Underlay present



Underlay tucked under panels



Hole Positions



Planting basket installation



Removing the fixing pin

Step 18

Before filling your Affinity Pool with water double check the strengthening wire loops around the specified feet are still in place and are secure, if not step 13 will need to be repeated before finishing this step. See image 1 for a visual of the correct installation of the strengthening wire required before the pond is filled.

Once all the previous steps have been completed, you can now fill your Affinity Pool with tap water. Ensure the tap water has been treated with a water dechlorinator as this will make it safe for your fish.

Only fill up to the eyelets on the liner bag rim, once filled you can turn on your Inpond ALL-IN-ONE filter (please see the filter instructions for correctly installing the pump/filter, using the lighting and water fountains).

Two planting baskets (part 7) and 4 fixing pins (part 8) are supplied which can be fitted to panels on the Affinity Pool. Each top rail has two centre holes underneath that allow the planting basket to be pinned in with the fixing pins supplied. Using a fixing pin, push fit into the hole attaching the basket into place. If you need to remove a planting basket use a small flat headed screwdriver on the inside screw head to gently remove from the fixed position as in image 4.

Additional baskets are available to purchase individually. Use pond compost to plant your chosen aquatic plants

Tip: To help guide and hide the filter cables use one of the planting baskets on the panel where the cables will come through.



Strengthening wire in place and secure



1

To keep your Affinity Pool windows clean, use **ONLY** the Affinity anti-scratch window cleaning pads code 1051200. Any other material may scratch or damage the windows. Polymer wool pads supplied are for the Inpond all-in-one filter, (see instruction manual).

All these items are available as replacements from your retailer.

For further information, see our website: www.affinitypools.co.uk

Guarantee

This product is guaranteed against defects in material and workmanship for 3 years from the date of purchase, under normal usage. The guarantee DOES NOT APPLY in case of improper use, negligence, lack of maintenance or accidental damage to the Affinity Pool. If the Affinity Pool fails due to a manufacturing fault within this period it will be either repaired or replaced free of charge. Liability is limited to replacement of the faulty product only; no other costs will be reimbursed.

This guarantee is not transferable and does not affect your statutory rights. This guarantee does not confer any rights other than those expressly set out above. Excludes consumable parts (pump Impellor, LED light & UVC lamp). If any parts are needed, spares are available from your retailer. Please see the Inpond 1400 instructions for more information and part descriptions.



Environment Friendly Disposal

You can help protect the environment! Please remember to respect the local regulations and hand in any non-working electrical equipment to an appropriate waste disposal centre.

Consumer Advice Contact Information

Interpet (Blagdon) Consumer Advice Department,
Vincent Lane, Dorking, Surrey RH4 3YX

Fax: 01306 876712 **E-mail:** customercare@interpet.co.uk
www.affinitypools.co.uk



IMPORTANT: PLEASE ATTACH PROOF OF PURCHASE TO THIS MANUAL AND FILE IN A SAFE PLACE.



INNOVATIVE

DESIGN
PATENT PENDING

Affinity feature pools have been designed by a leading British water gardening company. Over half a century of fish keeping and water gardening knowledge is brought together in this product, so you can be assured of a successful, creative water feature.