



affinity[®]
living feature pools

view corner

mocha weave & black aluminium
instructions



www.blagdonwatgardening.co.uk
www.pondaquariumproblemsolver.co.uk/blagdon

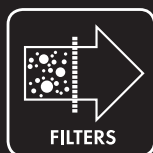

View Corner Assembly Instructions

Getting to know your Affinity living feature pool

Part List

Part Description	Quantity	Part No.
Tool	1	1
Plastic Keys	20	2
Plant Basket Fixing Pins	4	3
Plastic Feet	5	4
90° Trident Connector	3	5
A Top Rail (90°-90°)	2	6
A Mocha Weave Panel	2	7
90° Leg	3	8
B Top Rail (90°-135°)	2	9
B Mocha Weave Window Panel	2	10
C Top Rail (135°-135°)	1	11
C Mocha Weave Window Panel	1	12
135° Leg	2	13
B Leg Cross Brace Bar	3	14
135° Trident Connector	2	15
Underlay	1	16
Liner Bag	1	17
A Leg Cross Brace Bar	2	18
Plant Basket	1	19
Waterfall Clip	2	20
Waterfall Bracket	1	21
Waterfall	1	22

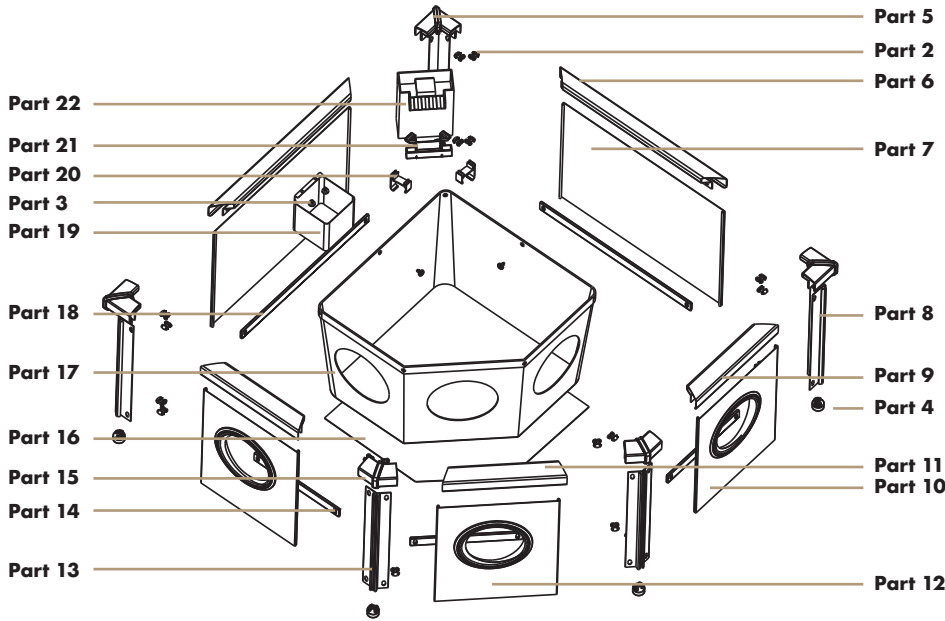

Part 1



Part 4



Part 3



Part 2

Also Available

Product Code	Product Name
1054690	Inpond 2000 Annual Maintenance Kit
1052245	Affinity Planting Basket
1051309	Inpond 5w UV Clarifier

Step by Step Guide

Step 1

Clear chosen area of debris and any sharp objects which could puncture the liner.

Step 2

Place down the supplied underlay and layout the all parts - check the quantities against the parts table.

Step 3

Connect the two A rails to a 90° trident connector.

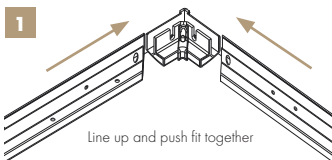

Step 4

Insert a 90° leg and lock in place with the supplied keys - ensure the end with the sticker is pointing up on every leg.

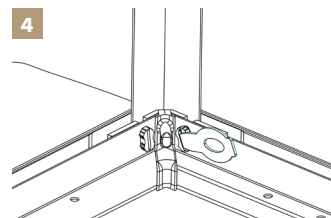
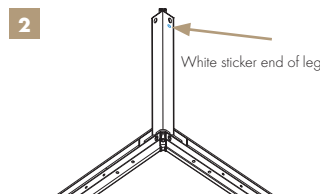
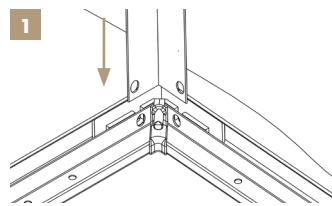

Step 5

Connect a 90° trident to one of the A rails and attach a B rail - insert a 90° leg and lock into place with the keys.

Step 6

Connect a 135° trident to this B rail, attach the C rail - insert a 135° leg and lock into place with the keys.

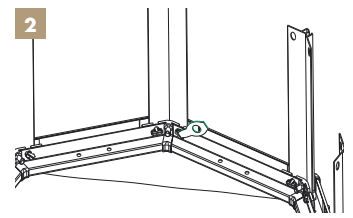
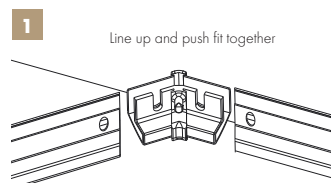

Step 7

Connect the last 135° trident to the C rail, connect the last 90° trident to the last B rail.

Step 8

Insert the B rail into the remaining gap - connecting the 90° trident to the A rail. Insert the 90° and 135° legs into the appropriate positions and lock into place with the keys.

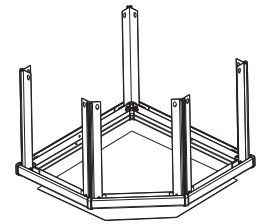
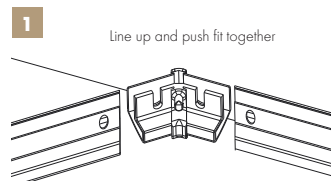
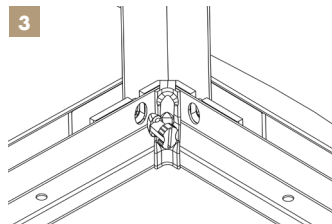
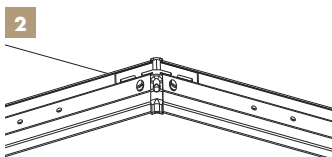

Step 9

Insert the A panels (without windows) across the legs on the A rails.

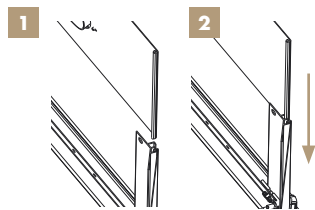

Step 13

Insert the leg cross braces labelled B across the gaps between the legs of the B rails - lock in place with the keys.

Step 14

Insert the leg cross brace labelled C across the gap between the legs of the C rail - lock in place with the keys.

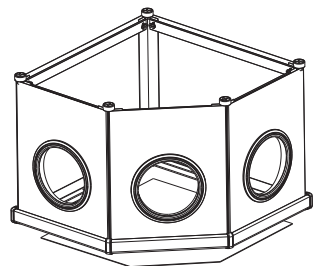

Step 10

Insert the B panels (with windows) across the legs on the B rails.

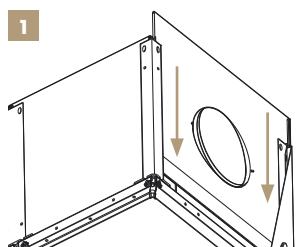

Step 15

Push the supplied feet onto the bottom of the legs.

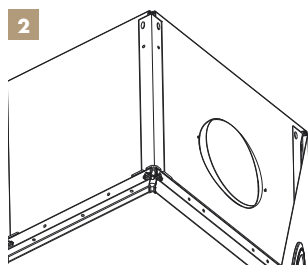

Step 11

Insert the C panel (with window) across the legs on the C rail.

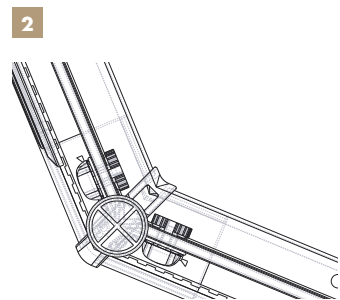
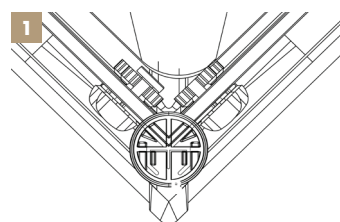

Step 16

Between two people turn the frame over.

Step 17

Place the liner bag inside the frame and open it up - turn the liner to align the clear windows with the portholes on the weave panels.

Step 18

Working around the liner hook the eyelets onto the hooks on the trident connectors.

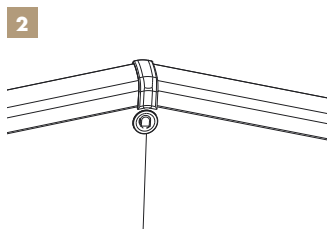
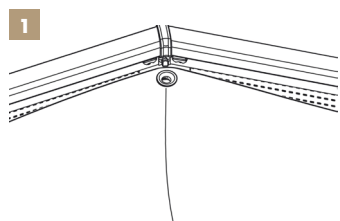

Step 19

Using plant basket fixing pins, pin up the rest of the liner eyelets onto the vertical face of the top rails.

Step 20

Using the plant basket fixing pins attach the plant baskets to the underside of the top rail.

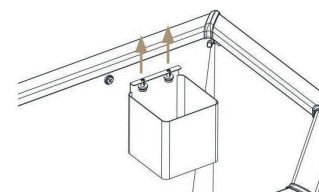

Step 21

Place the Inpond filter into the pool and run the cables out of the back corner.

Step 22

Attach the waterfall bracket to the waterfall clips.

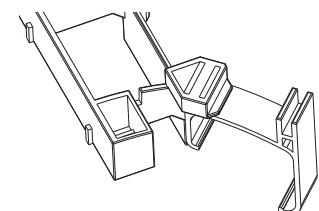

Step 23

Clip the waterfall bracket onto the top rail across the back corner (ensuring the cables for the filter are in between the clips). Attach the supplied waterfall.

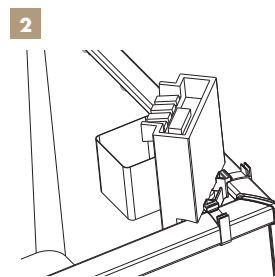
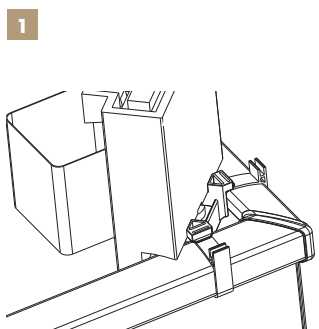

Step 24

Connect the waterfall hose to the Inpond outlet, fill the pond with dechlorinated water and enjoy.

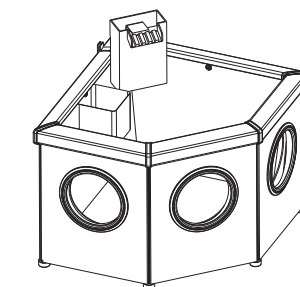

Tip: Use the flat face of the provided tool to make it easier to push in the plant fixing pins.

Tip: To make installation of the leg cross braces easier, allow the weave panels to warm up prior to use - place in direct sunlight for 20-30 minutes, or place them in an airing cupboard overnight if building the pool during the winter.

Step 12

Insert the leg cross braces labelled A across the gaps between the legs of the A rails - lock in place with the keys.

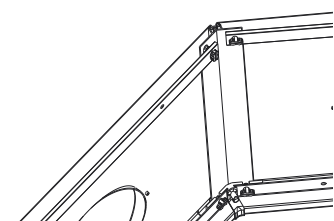

affinity accessories



Split Rill Waterfall



Wave Rill Waterfall



Window Cleaning Pads



Planting Baskets



Green Water UV Clarifier



Ice Vent Heater



Maintenance Kits

To keep your Affinity Pool windows clean, use **ONLY** the Affinity anti-scratch window cleaning pads code 1051200. Any other material may scratch or damage the windows. Polymer wool pads supplied are for the Inpond 5 in 1 filter, (see instruction manual).

All these items are available as replacements from your retailer.

For further information, see our website:
www.blagdonwatgardening.co.uk

Guarantee

This product is guaranteed against defects in material and workmanship for 3 years from the date of purchase, under normal usage. The guarantee DOES NOT APPLY in case of improper use, negligence, lack of maintenance or accidental damage to the Affinity Pool. If the Affinity Pool fails due to a manufacturing fault within this period it will be either repaired or replaced free of charge. Liability is limited to replacement of the faulty product only; no other costs will be reimbursed.

This guarantee is not transferable and does not affect your statutory rights. This guarantee does not confer any rights other than those expressly set out above. Excludes consumable parts (pump Impellor, LED light). If any parts are needed, spares are available from your retailer. Please see the Inpond 5 in 1 2000 instructions for more information and part descriptions.



Environment Friendly Disposal

You can help protect the environment! Please remember to respect the local regulations and hand in any non-working electrical equipment to an appropriate waste disposal centre.

Product code: 1057622

Consumer Advice Contact Information

Interpet (Blagdon) Consumer Advice Department,
Vincent Lane, Dorking, Surrey RH4 3YX
E-mail: customercare@interpet.co.uk
www.blagdonwatgardening.co.uk

IMPORTANT: PLEASE ATTACH PROOF OF PURCHASE TO THIS MANUAL AND FILE IN A SAFE PLACE.



Affinity feature pools have been designed by a leading British water gardening company. Over half a century of fish keeping and water gardening knowledge is brought together in this product, so you can be assured of a successful, creative water feature.