

EVO10511201MAN

UK/EU English

EVOLUTION
AQUA

INNOVATION IN WATER

evofeed
AUTOMATIC

INSTALLATION AND OPERATING MANUAL

WARNING: PLEASE READ THE FOLLOWING SAFETY INFORMATION FIRST.

IMPORTANT SAFETY INFORMATION



- Keep out of reach of children
- When charging the battery, keep out of the rain, away from combustible or explosive materials.
- Built-in battery can't be stored in the condition of no power. If it is not used for a long time, please charge it for three hours every six months to maintain battery life.
- Do not use any other power adapter other than the one supplied.
- Always install at the side of a pond, never in the pond.
- Avoid exposure to direct sunlight.

PRODUCT INFORMATION

Capacity: 6 Litres

Feeding per day: 1 - 6 times

Lithium battery capacity: 2200mA

Adapter specification: 12V 1.66A

Dimensions: 37 x 31 x 40cm

Disposal Of Your Old Product

Your product is designed and manufactured with high quality material and components, which can be recycled and reused. When this crossed-out wheeled bin symbol is attached to a product, it means the product is covered by the European Directive 2002/96/EC. Please contact your local authority about correct disposal for electrical and electronic equipment. Our WEEE Registration Number is WEE/FE1471RR.

Please act according to your local rules and do not dispose of your old products with your normal household waste. The correct disposal of your old product will help prevent potential negative consequences for the environment and human health.



INTRODUCING EVOFEED AUTOMATIC

evoFeed Automatic is an automatic fish feeder suitable for medium and large ponds. The unit can be programmed to dispense food into the pond at timed intervals throughout the day. The distance the food is propelled, and the amount of time it is dispensed for, are also adjustable. The food is propelled at a 120-degree angle.

Weatherproof, evoFeed Automatic can be mounted pond side, and is powered via its own built-in rechargeable battery. Once charged, no additional power cable is necessary.

evoFeed Automatic is ideal for koi ponds, where large quantities of pellets are fed, and fish fed frequently throughout the day in order to maintain growth. It is also ideal for holiday feeding.

The feeder has a large LCD screen and control panel and can easily be set to feed up to six times daily. It is also possible to perform a manual feed from the control panel.

The feeder is designed to use pellets from 3-10 mm diameter. We do not recommend the use of sticks, flakes or other shapes of food.

The rechargeable lithium battery only needs an overnight charge indoors, to then operate for at least 3 months powered by its own battery, depending of the timer setting. Adapter for charging is included.

evoFeed Automatic is specially designed with a strong motor and extra bottom ventilation over the impeller to prevent the food from clogging.

Fixing pegs are included, which makes it easy to place and secure the feeder at the edge of your pond.

SETTING UP THE FEEDER (STEP-BY-STEP)



1. Remove the feeder from the box.



2. Take the legs out of the food container and assemble as shown.



3. Remove lid, turn the unit upside down, and mount the legs as shown.



4. Secure the legs in place using the screws provided.



5. Use a screwdriver to unscrew the three screws to remove the cover.



6. Take the battery from the spare parts bag.

SETTING UP THE FEEDER (STEP-BY-STEP)

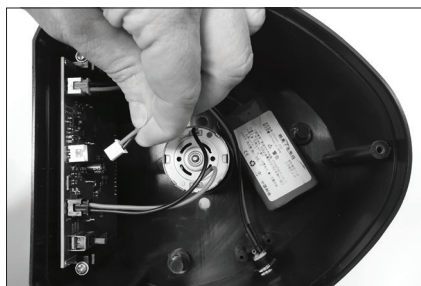

7. Fit battery plug into socket on PCB board.

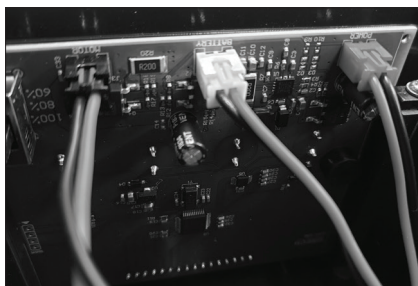

8. Battery plug should be fitted as shown above.



9. Re-fit the cover.



10. Plug into mains and charge overnight.



11. Set time by pressing set once to set hours and twice to set minutes.



12. Fit feeding chute.

SETTING UP THE FEEDER (STEP-BY-STEP)

Display overview

The touch panel provides an easy way to program Your feeder.

"Set" saves and jump to the next input.

"Run" have 2 functions:

- A. Short press saves and exit
- B. Long press distribute 3 seconds of food

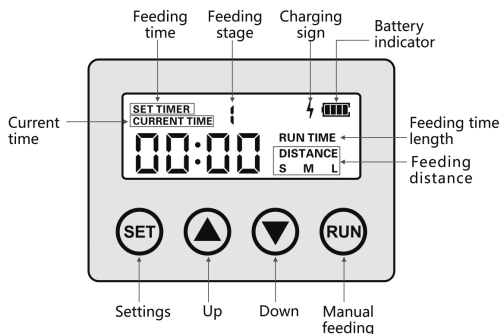

How to set time and distance for the food

Depending on the size of your pond, you can set the feeder motor for 3 different distances.

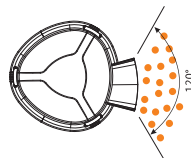

As a reference, normal 6 mm koi pellets have the following approximate spread:

Short (60%): 1 m. **Medium (80%):** 2 m. **Long (100%):** 3 m.

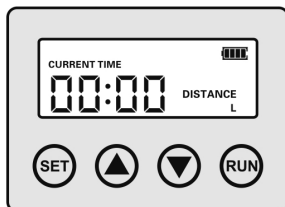

1. Press the 'SET' button, enter the current time; Hour and press SET, Minutes and press SET
2. Set the distance at Short (60%), Medium (80%) or Long (100%) as preferred and press SET.
3. Press the RUN button for 5 sec. to see distance

4. Test with your preferred food and repeat step 1-3 to find the best setting.

How to set amount of preferred food

The timing and amount of food varies on the basis of the type, pellet size, and weight of the food.

You can set the timer up to 6 times a day for a feeding period of up to 20 seconds. As a reference, a handful of normal 6 mm koi pellets requires about 3-5 seconds of operation.

5. Set the timers for feeding time and amount of 2 min. ahead (follow timer instruction on next page 8-10)
6. Hold a plastic bag in front of the outlet and check the amount of food after the feeding.
7. Adjust the running time for your preferred amount of food by repeating step 5-6.

SETTING UP THE FEEDER (STEP-BY-STEP)

How to set the timer

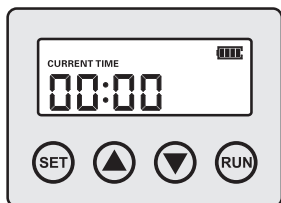

8. Press the 'SET' button past the time and distance setting (1-2)

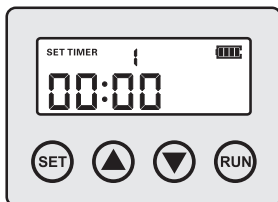

9. Choose the time you want your first feeding to occur and press 'SET'.

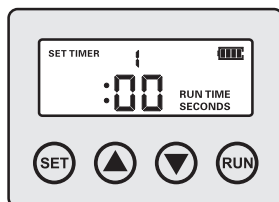

10. Choose the amount of food in seconds, up to 20 seconds and press 'SET'.

- 11.** If you only want to set one or a few feeding times, you do not need to press 'set' all the way through the 6 options. You can just press "Run" shortly or wait about 5 seconds – then the feeder will automatically save your setting and resume normal operation.
- 12.** To set up to 6 feedings, you will have to use the 'SET' button all the way through the 6 settings.

As an addition to the timer setting, you can always perform a manual 3 sec. feeding by pressing the 'RUN' button for around 5 seconds.

If You want to do a full reset - remove the battery wire for 30 seconds:



Open the cover below the touch panel by removing the 3 screws.



Make sure that the battery wire is reconnected and close the cover.

MAINTENANCE

Maintenance is not usually required, but depending on the type of food you use, the feeding operation might create some dust. If required, you can use a dry cloth to remove – the feeder is easily dismantled. If you wish to clean the food container with water, you need to dismantle it from the lower body first.

Make sure everything is dry before you reassemble, as water will damage the motor and electronics.

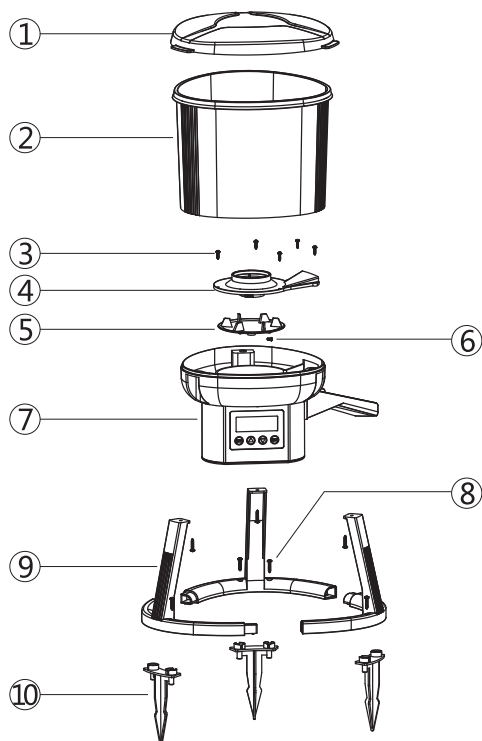

- | | |
|------------------------------|--|
| 1. Container cover | 7. Lower body with control panel, LCD-screen and battery (open bottom cover to access) |
| 2. Food container | 8. Screws for legs |
| 3. Screws for impeller cover | 9. Legs |
| 4. Impeller cover | 10. Fixing pegs |
| 5. Impeller | |
| 6. Screw for impeller | |

USE WITH EVOLUTION AQUA FOODS

Evolution Aqua's fish food range has been developed by people who not only care about fishkeeping, but have a proven know-how. We only use ingredients of the highest quality to promote all aspects of health, growth and development.



GROWTH*Plus*

GrowthPlus is available in four sizes 800g, 2kg, 6kg, and 15kg, in 5-6mm (medium) pellet size.



PREMIER

Premier is available in four sizes 800g, 2kg, 6kg, and 15kg, all in 2 pellet sizes; 3-4mm (small) and 5-6mm (medium).



WHEATGERM

Wheatgerm is available in four sizes 800g, 2kg, 6kg, and 15kg, all in 2 pellet sizes; 3-4mm (small) and 5-6mm (medium).

Visit www.evolutionaqua.com for more information about our range of fish foods

GUARANTEE

This product is guaranteed against defects in material and workmanship for 2 years from the date of purchase, under normal usage. The guarantee DOES NOT APPLY in case of improper use, negligence, lack of maintenance or accidental damage to the product. If the product fails due to a manufacturing fault within this period it will be either repaired or replaced free of charge.

The battery is not covered by warranty and can be ordered as a replacement part.

Liability is limited to replacement of the faulty product only; no other costs will be reimbursed. This guarantee is not transferable and does not affect your statutory rights. This guarantee does not confer any rights other than those expressly set out above.

The manufacturer or supplier shall not be responsible, or held liable for any damages caused by defective components or materials of this product; or for loss incurred by interruption of service; or any consequential / incidental damages and expenses arising from the production, sale use or misuse of this product or any other consequential loss.

Any warranty claim must be accompanied by a valid, dated proof of purchase.

Evolution Aqua and its dealers shall not be held liable for any loss of fish, plants or any other livestock as a result of any failure or defect of this product.

The installation and use of your product outside of our recommendations as printed in this manual may also void the warranty.

Evolution Aqua are the award winning pond filtration manufacturer who put innovation, research and development at the top of their agenda. With a proven track record for delivering the latest technology to the aquatics and fish farming markets - we are the first choice for everyone from the general hobbyist to the serious fishkeeper. Find out more about our other innovative products at www.evolutionaqua.com. The difference is clear.

° °
EVOLUTION
AQUA

° °
INNOVATION IN WATER

Evolution Aqua Ltd

Evolution House

Kellet Close

Wigan

Lancashire

United Kingdom

WN5 0LP

t: +44 (0) 1942 216554

f: +44 (0) 1942 418489

e: info@evolutionaqua.com

w: www.evolutionaqua.com